

LOW NOISE GENERAL PURPOSE AUDIO AMPLIFIERS

DESCRIPTION

The BC107 and BC108 are silicon planar epitaxial NPN transistors in TO-18 metal case. They are suitable for use in driver stages, low noise input stages and signal processing circuits of television receivers. The PNP complement for BC107 is BC177.

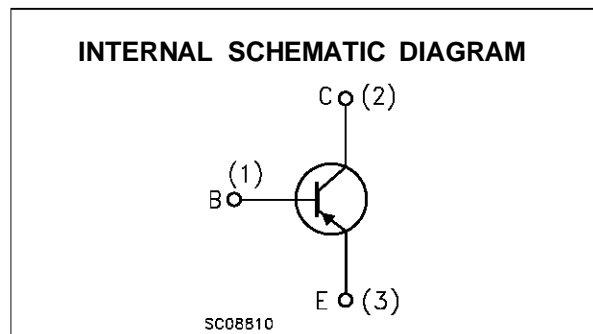
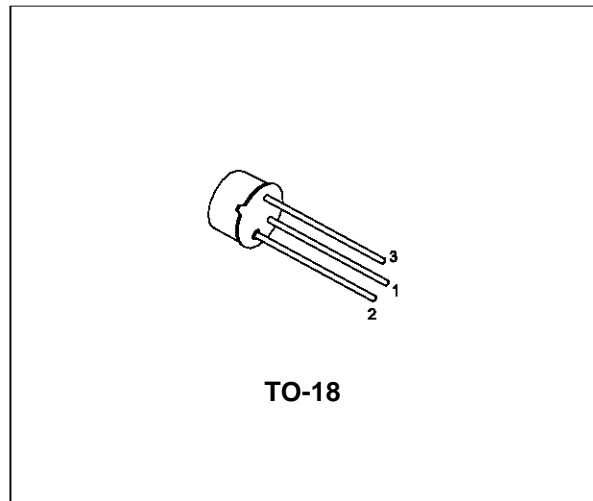

ABSOLUTE MAXIMUM RATINGS

| Symbol | Parameter | Value | | Unit |
|-----------|---|------------|-------|------------------|
| | | BC107 | BC108 | |
| V_{CBO} | Collector-Base Voltage ($I_E = 0$) | 50 | 30 | V |
| V_{CEO} | Collector-Emitter Voltage ($I_B = 0$) | 45 | 20 | V |
| V_{EBO} | Emitter-Base Voltage ($I_C = 0$) | 6 | 5 | V |
| I_C | Collector Current | 100 | | mA |
| P_{tot} | Total Dissipation at $T_{amb} \leq 25\text{ }^\circ\text{C}$ at $T_{case} \leq 25\text{ }^\circ\text{C}$ | 0.3 | | W |
| | | 0.75 | | W |
| T_{stg} | Storage Temperature | -55 to 175 | | $^\circ\text{C}$ |
| T_j | Max. Operating Junction Temperature | 175 | | $^\circ\text{C}$ |

BC107/BC108

THERMAL DATA

| | | | | |
|-----------------------|-------------------------------------|-----|-----|------|
| R _{thj-case} | Thermal Resistance Junction-Case | Max | 200 | °C/W |
| R _{thj-amb} | Thermal Resistance Junction-Ambient | Max | 500 | °C/W |

ELECTRICAL CHARACTERISTICS (T_{case} = 25 °C unless otherwise specified)

| Symbol | Parameter | Test Conditions | Min. | Typ. | Max. | Unit |
|-----------------------|--|---|--|--|---|----------------------|
| I _{CBO} | Collector Cut-off Current (I _E = 0) | for BC107 V _{CB} = 40 V V _{CB} = 40 V T _{case} = 150 °C for BC108 V _{CB} = 20 V V _{CB} = 20 V T _{case} = 150 °C | | | 15 15 15 15 | nA μA μA μA |
| V _{(BR)CBO} | Collector-Base Breakdown Voltage (I _E = 0) | I _C = 10 μA for BC107 for BC108 | 50 30 | | | V V |
| V _{(BR)CEO*} | Collector-Emitter Breakdown Voltage (I _B = 0) | I _C = 10 mA for BC107 for BC108 | 45 20 | | | V V |
| V _{(BR)EBO} | Emitter-Base Breakdown Voltage (I _C = 0) | I _E = 10 μA for BC107 for BC108 | 6 5 | | | V V |
| V _{CE(sat)*} | Collector-Emitter Saturation Voltage | I _C = 10 mA I _B = 0.5 mA I _C = 100 mA I _B = 5 mA | | 70 200 | 250 600 | mV mV |
| V _{BE(sat)*} | Base-Emitter Saturation Voltage | I _C = 10 mA I _B = 0.5 mA I _C = 100 mA I _B = 5 mA | | 750 950 | | mV mV |
| V _{BE(on)*} | Base-Emitter On Voltage | I _C = 2 mA V _{CE} = 5 V I _C = 10 mA V _{CE} = 5 V | 550 | 650 700 | 700 770 | mV mV |
| h _{FE*} | DC Current Gain | I _C = 2 mA V _{CE} = 5 V for BC107 for BC107 Gr. A for BC107 Gr. B for BC108 for BC108 Gr. A for BC108 Gr. B for BC108 Gr. C I _C = 10 μA V _{CE} = 5 V for BC107 for BC107 Gr. A for BC107 Gr. B for BC108 for BC108 Gr. A for BC108 Gr. B for BC108 Gr. C | 110 110 200 110 110 200 420 40 100 | 120 90 150 120 90 150 270 | 450 220 450 800 220 450 800 | |
| h _{fe*} | Small Signal Current Gain | I _C = 2 mA V _{CE} = 5 V f = 1KHz for BC107 for BC107 Gr. A for BC107 Gr. B for BC108 for BC108 Gr. A for BC108 Gr. B for BC108 Gr. C I _C = 10 mA V _{CE} = 10 V f = 100 MHz | | 250 190 300 370 190 300 500 2 | | |

* Pulsed: Pulse duration = 300 μs, duty cycle ≤ 1 %

ELECTRICAL CHARACTERISTICS (continued)

| Symbol | Parameter | Test Conditions | Min. | Typ. | Max. | Unit |
|------------------|----------------------------|--|------|---|------|--|
| C _{CB0} | Collector Base Capacitance | I _E = 0 V _{CB} = 10 V f = 1MHz | | 4 | 6 | pF |
| C _{EBO} | Emitter Base Capacitance | I _C = 0 V _{EB} = 0.5 V f = 1MHz | | 12 | | pF |
| NF | Noise Figure | I _C = 0.2 mA V _{CE} = 5 V f = 1KHz R _g = 2KΩ B = 200Hz | | 2 | 10 | dB |
| h _{ie} | Input Impedance | I _C = 2 mA V _{CE} = 5 V f = 1KHz for BC107 for BC107 Gr. A for BC107 Gr. B for BC108 for BC108 Gr. A for BC108 Gr. B for BC108 Gr. C | | 4 3 4.8 5.5 3 4.8 7 | | KΩ KΩ KΩ KΩ KΩ KΩ KΩ |
| h _{re} | Reverse Voltage Ratio | I _C = 2 mA V _{CE} = 5 V f = 1KHz for BC107 for BC107 Gr. A for BC107 Gr. B for BC108 for BC108 Gr. A for BC108 Gr. B for BC108 Gr. C | | 2.2 1.7 2.7 3.1 1.7 2.7 3.8 | | 10 ⁻⁴ 10 ⁻⁴ 10 ⁻⁴ 10 ⁻⁴ 10 ⁻⁴ 10 ⁻⁴ 10 ⁻⁴ |
| h _{oe} | Output Admittance | I _C = 2 mA V _{CE} = 5 V f = 1KHz for BC107 for BC107 Gr. A for BC107 Gr. B for BC108 for BC108 Gr. A for BC108 Gr. B for BC108 Gr. C | | 30 13 26 30 13 26 34 | | μS μS μS μS μS μS μS |

* Pulsed: Pulse duration = 300 μs, duty cycle ≤ 1 %

DC Normalized Current Gain.

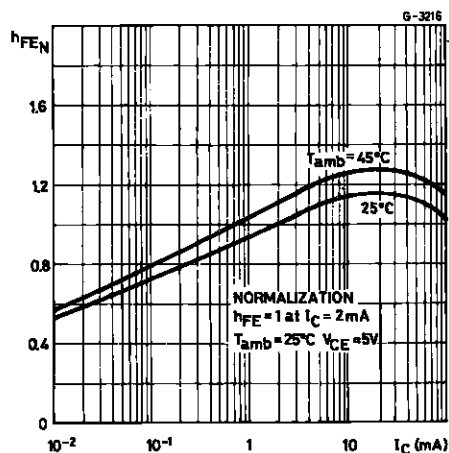

Collector--emitter Saturation Voltage.

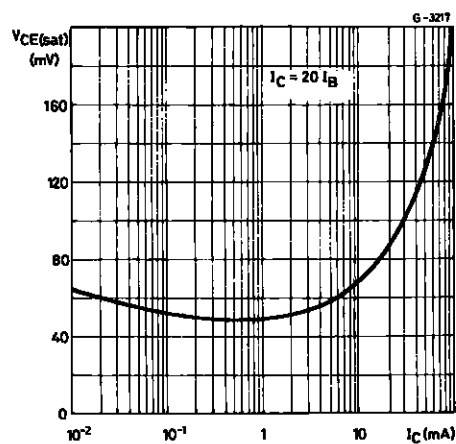

Collector-base Capacitance.

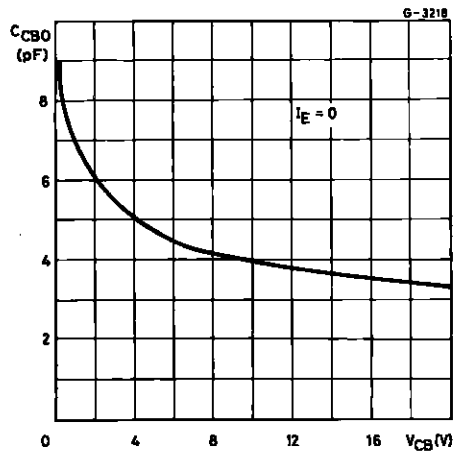

Transition Frequency.

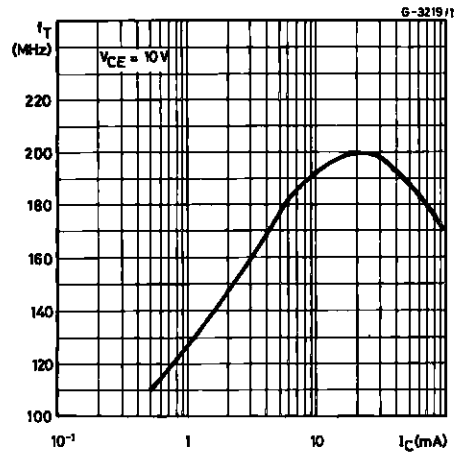

Power Rating Chart.

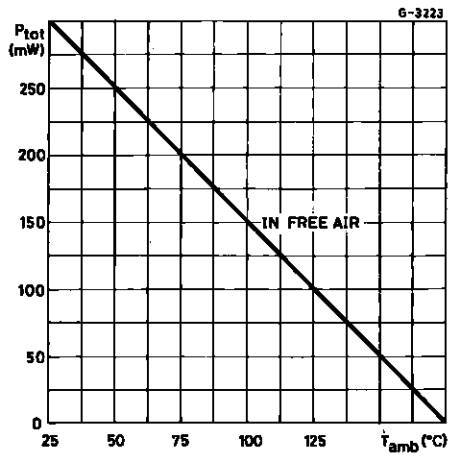

TO-18 MECHANICAL DATA

| DIM. | mm | | | inch | | |
|------|------|------|------|-------|-------|-------|
| | MIN. | TYP. | MAX. | MIN. | TYP. | MAX. |
| A | | 12.7 | | | 0.500 | |
| B | | | 0.49 | | | 0.019 |
| D | | | 5.3 | | | 0.208 |
| E | | | 4.9 | | | 0.193 |
| F | | | 5.8 | | | 0.228 |
| G | 2.54 | | | 0.100 | | |
| H | | | 1.2 | | | 0.047 |
| I | | | 1.16 | | | 0.045 |
| L | 45° | | | 45° | | |

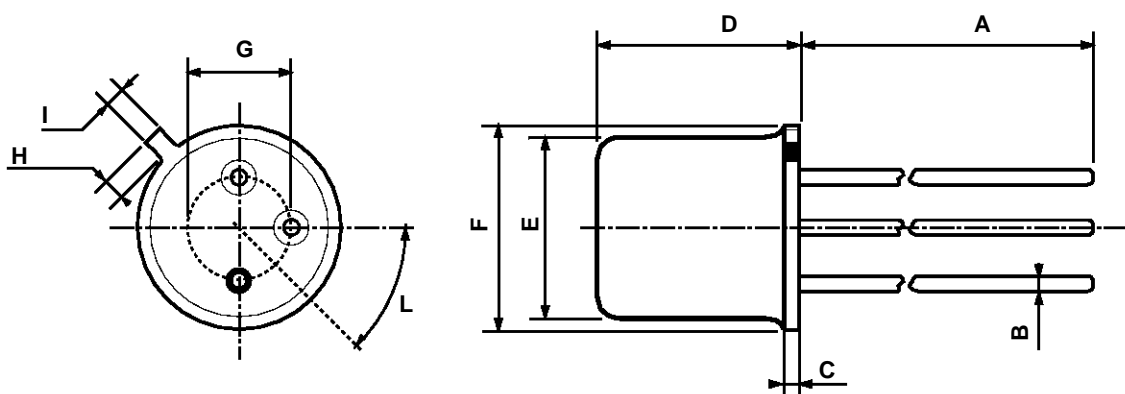

0016043

Information furnished is believed to be accurate and reliable. However, SGS-THOMSON Microelectronics assumes no responsibility for the consequences of use of such information nor for any infringement of patents or other rights of third parties which may result from its use. No license is granted by implication or otherwise under any patent or patent rights of SGS-THOMSON Microelectronics. Specifications mentioned in this publication are subject to change without notice. This publication supersedes and replaces all information previously supplied. SGS-THOMSON Microelectronics products are not authorized for use as critical components in life support devices or systems without express written approval of SGS-THOMSON Microelectronics.

© 1997 SGS-THOMSON Microelectronics - Printed in Italy - All Rights Reserved

SGS-THOMSON Microelectronics GROUP OF COMPANIES

Australia - Brazil - Canada - China - France - Germany - Italy - Japan - Korea - Malaysia - Malta - Morocco - The Netherlands -
Singapore - Spain - Sweden - Switzerland - Taiwan - Thailand - United Kingdom - U.S.A

...

This datasheet has been download from:

www.datasheetcatalog.com

Datasheets for electronics components.